

SETUPS

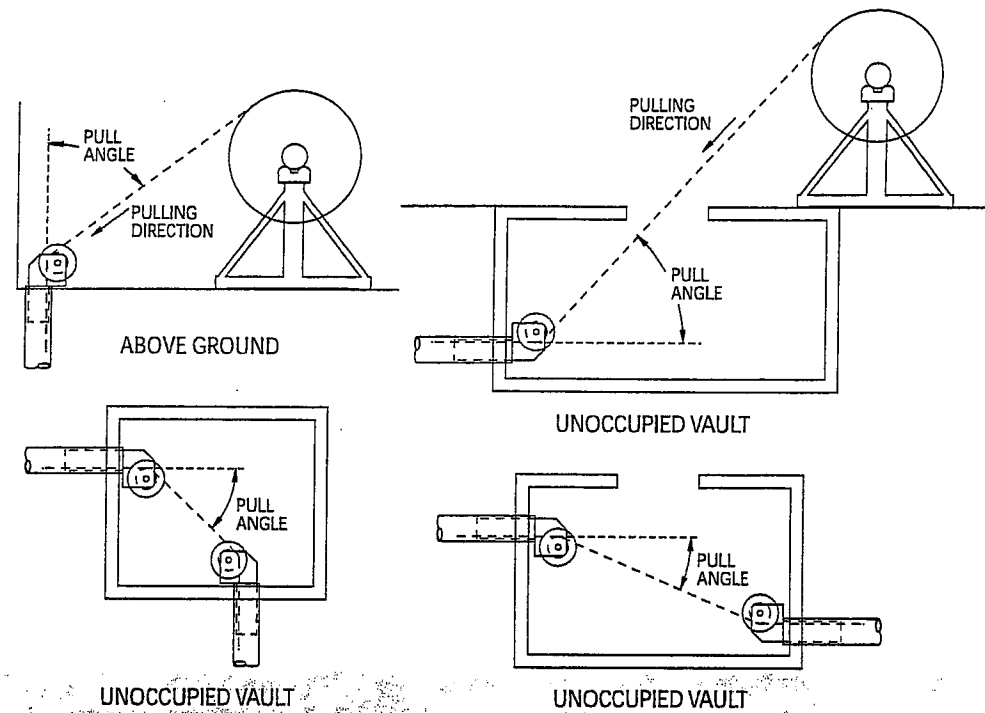

EXPLODED VIEW

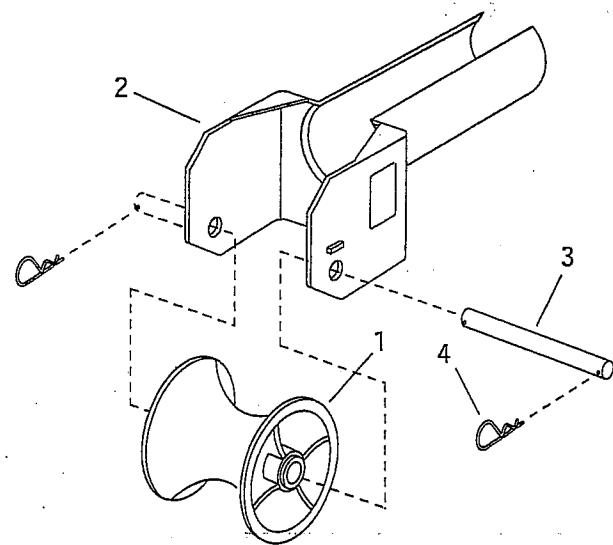

PARTS LIST

Item #	Parts Description	Qty.	Part # 520FS	Part # 525FS	Part # 530FS	Part # 535FS	Part # 540FS	Part # 550FS	Part # 560FS
1	Sheave	1	406-4	406-4	406-4	406-4	406-4	406-4	406-4
2	Main Body	1	520FS-1	525FS-1	530FS-1	535FS-1	540FS-1	550FS-1	560FS-1
3	Pin	1	406-2	406-2	406-2	406-2	406-2	406-2	560FS-5
4	Spring Clip	2	406-3	406-3	406-3	406-3	406-3	406-3	406-3

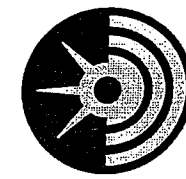

Current Tools
FOR THE PROFESSIONAL ELECTRICIAN

500FS Series Cable Feeding Sheaves

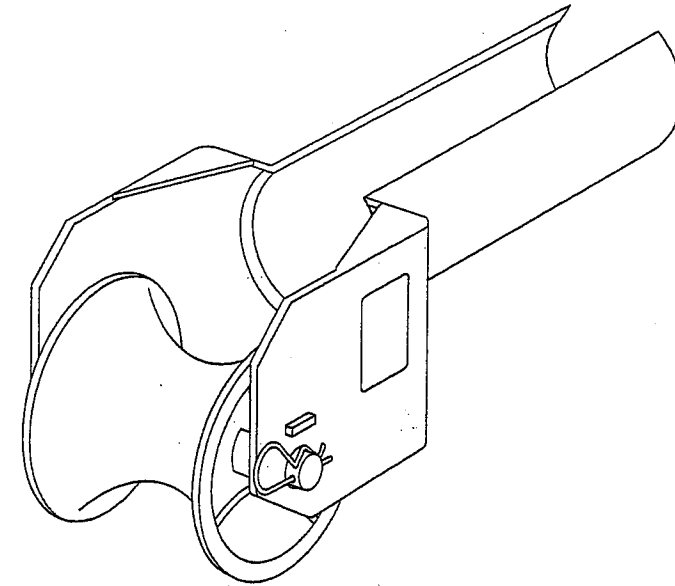

Instruction Manual

04/09 REV.0



Read and understand this material before using the Cable Feeding Sheave. Failure to understand how to safely use this unit may result in serious injury or death.

This manual is free of charge. All personnel who use the Cable Feeding Sheave should have a copy of this instruction manual and read and understand its contents. To request a copy of this manual or replacement safety decals, or for technical assistance, call or write to the address below.

CURRENT TOOLS • P. O. BOX 17026 GREENVILLE, SC 29606
800.230.5421 or 864.244.1201 • FAX 864.244.5860
www.currenttools.com

SAFETY ALERTS



Safety Alert Symbol

THIS SAFETY SYMBOL is used to call your attention to instructions that concern your personal safety. It means: ATTENTION! BE AWARE! THIS IS AN IMPORTANT SAFETY INSTRUCTION!

Read, understand, and follow these safety instructions. Failure to follow these safety instructions may result in injury or death.

⚠ DANGER

Immediate hazards which, if not avoided, WILL result in serious personal injury or death.

⚠ WARNING

Hazards or unsafe practices which, if not avoided, COULD result in serious personal injury or death.

⚠ CAUTION

Hazards or unsafe practices which, if not avoided, COULD result in minor personal injury or property damage.

RETAIN SAFETY INFORMATION



This instruction manual should be read and understood by all personnel who use the Cable Feeding Sheave. Failure to understand how to safely use this equipment could result in serious injury or death. This equipment should only be used by qualified personnel.

IMPORTANT SAFETY INFORMATION

- ⚠ WARNING** READ and understand instruction manual before use.
- ⚠ WARNING** NEVER stand in the direct line of the pull.
- ⚠ WARNING** ALWAYS ensure conduit is capable of supporting the maximum pulling load.
- ⚠ WARNING** NEVER exceed the maximum pulling load at the pull angle specified in the capacity table. Doing so may damage the cable and the feeding sheave.
- ⚠ WARNING** NEVER exceed the cable manufacturer's specified pulling force or bend radius of the cable.
- ⚠ WARNING** ALWAYS match the feeding sheave with the corresponding conduit size.
- ⚠ WARNING** Only use this feeding sheave with Current Tools double braided cable pulling rope. NEVER use with steel cable.

APPLICATIONS

For above ground feeding of cable into conduit (See Figure 1) or for use in unoccupied manhole or vault (See Figure 2).

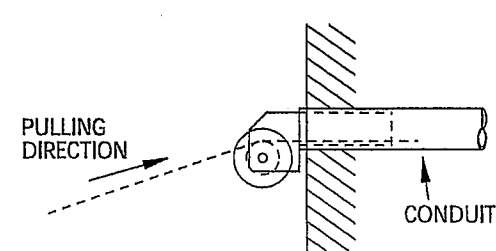

ABOVE GROUND
(FEED INTO CONDUIT ONLY)

Figure 1

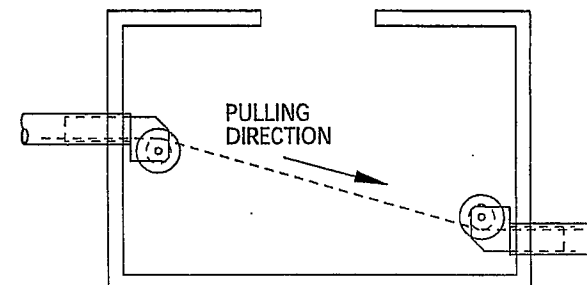

UNOCCUPIED MANHOLE OR VAULT

Figure 2

OPERATING INSTRUCTIONS

1. Slide the split tube portion of the feeding sheave frame into the conduit.
2. The split tube must be completely inserted into the conduit to avoid potential injury or damage to conduit.
3. The split tube allows for easy removal of the feeding sheave when the pull is complete.

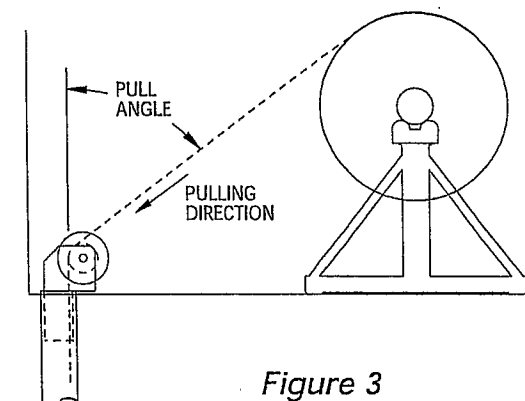

Figure 3

FEEDING SHEAVE CAPACITY TABLE

PULL ANGLE	520FS	525FS	530FS	535FS	540FS	550FS	560FS
15°	1750 lbs.	1900 lbs.	6050 lbs.	8000 lbs.	8000 lbs.	8000 lbs.	8000 lbs.
30°	900 lbs.	1000 lbs.	3150 lbs.	5050 lbs.	7000 lbs.	8000 lbs.	8000 lbs.
45°	650 lbs.	700 lbs.	2200 lbs.	3550 lbs.	5200 lbs.	7400 lbs.	7400 lbs.
60°	500 lbs.	550 lbs.	1800 lbs.	2900 lbs.	4200 lbs.	6000 lbs.	6000 lbs.
75°	450 lbs.	500 lbs.	1600 lbs.	2600 lbs.	3650 lbs.	5500 lbs.	5500 lbs.
90°	450 lbs.	500 lbs.	1550 lbs.	2500 lbs.	3500 lbs.	5250 lbs.	5250 lbs.

MODEL NUMBER	CONDUIT SIZE
520FS	2"
525FS	2 1/2"
530FS	3"
535FS	3 1/2"
540FS	4"
550FS	5"
560FS	6"